



**Creazione di un Ambiente Domestico Sicuro**

[www.progetto-cads.it](http://www.progetto-cads.it)



*Ministero dell'Università  
e della Ricerca*

# IL GRUPPO DI TECNICA DELLE COSTRUZIONI



Prof. Maria Antonietta Aiello  
*Lab Head*



Prof. Marianovella Leone



Prof. Francesco Micelli



Ing. Daniele Perrone



Ing. Alessio  
Cascardi



Ing. Gianni Blasi



Ing. Fabio Longo



Ing. Vincenzo  
Romanazzi



Ing. Ottavio  
Tamborrino



Ing. Giovanni  
Tondo



Ing. Fabiano De  
Vitis



Ing. Milena Casto



Ing. Giuseppe  
Bramato



Ing. Alessia  
Sticchi



Ing. Giuseppe  
Martina

*Il Team*





# IL GRUPPO DI TECNICA DELLE COSTRUZIONI



*I Laboratori*



# LE ATTIVITÀ DEL LABORATORIO DI TECNICA DELLE COSTRUZIONI



RINFORZO DI  
STRUTTURE ESISTENTI  
CON MATERIALI  
INNOVATIVI



SPERIMENTAZIONE DI  
MATERIALI PER  
L'EDILIZIA SOSTENIBILE

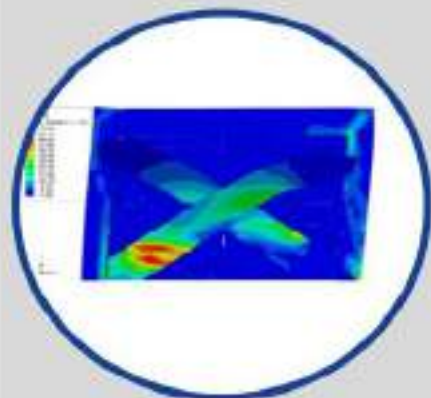

ANALISI DEL  
COMPORTAMENTO  
SISMICO DELLE  
STRUTTURE ED  
ELEMENTI  
NONSTRUTTURALI



DIAGNOSTICA SU  
STRUTTURE ESISTENTI

*Le principali  
attività del  
Gruppo*





# LE ATTIVITÀ DEL LABORATORIO DI TECNICA DELLE COSTRUZIONI

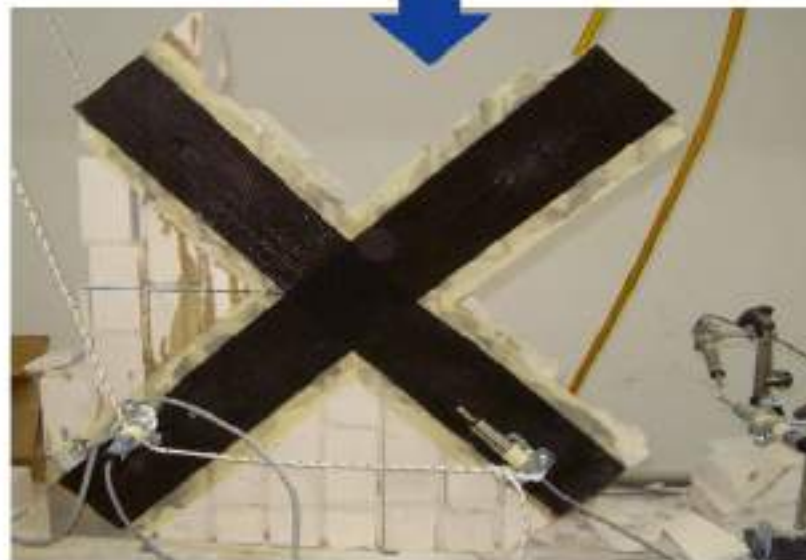
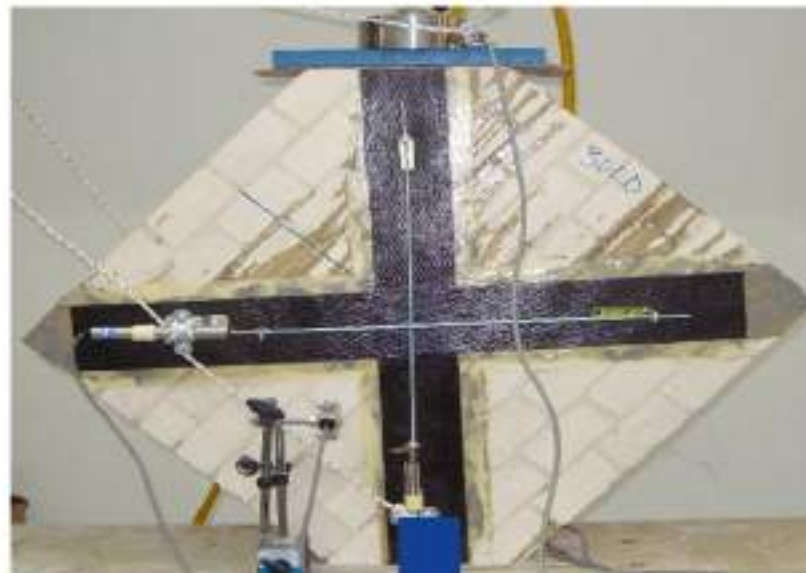

*Test su  
elementi  
rinforzati con  
FRP*

# LE ATTIVITÀ DEL LABORATORIO DI TECNICA DELLE COSTRUZIONI



*Test su  
elementi  
rinforzati con  
FRP*





# PROVE CICLICHE DI GIUNTI IMPIANTI SPRINKLER

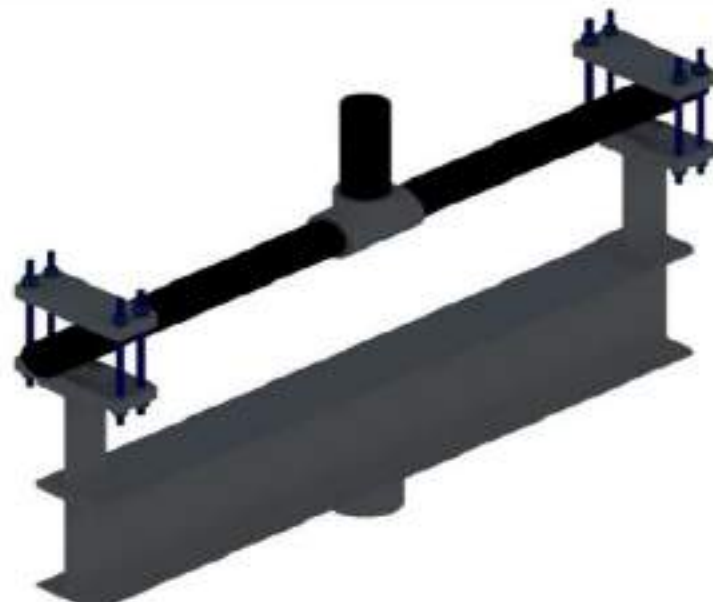

*Prove  
sperimentali  
su giunti di  
impianti*

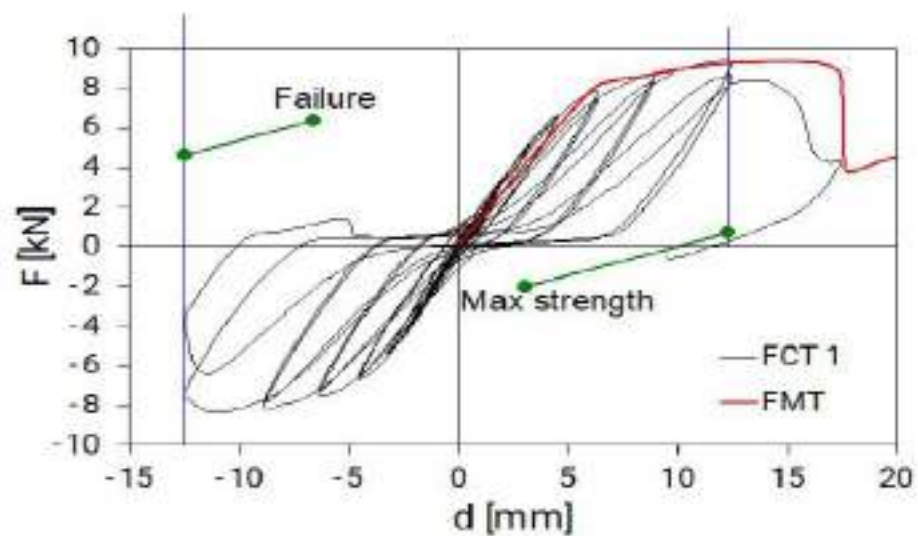



## PROVE CICLICHE DI GIUNTI IMPIANTI GAS MEDICALI

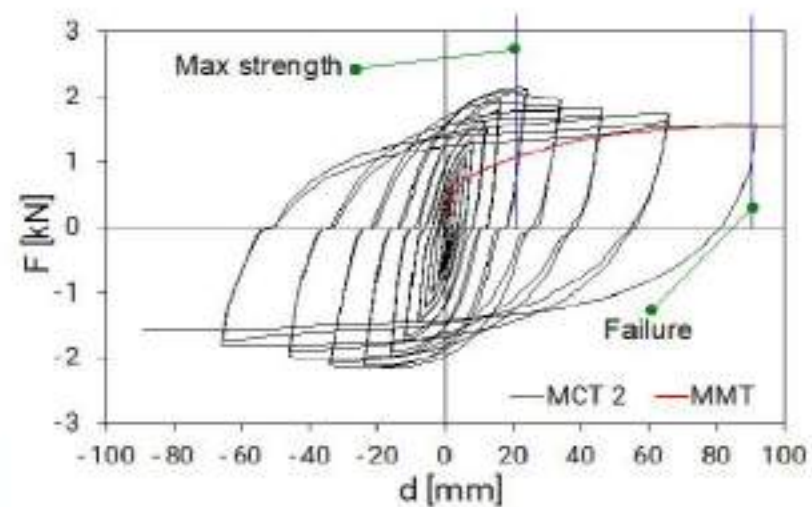

*Prove  
sperimentali  
su giunti di  
impianti*

# VALUTAZIONE DELLE PERFORMANCE DI PANNELLI EPS PER FINI STRUTTURALI



*Prove di  
flessione su  
pannelli in  
EPS*

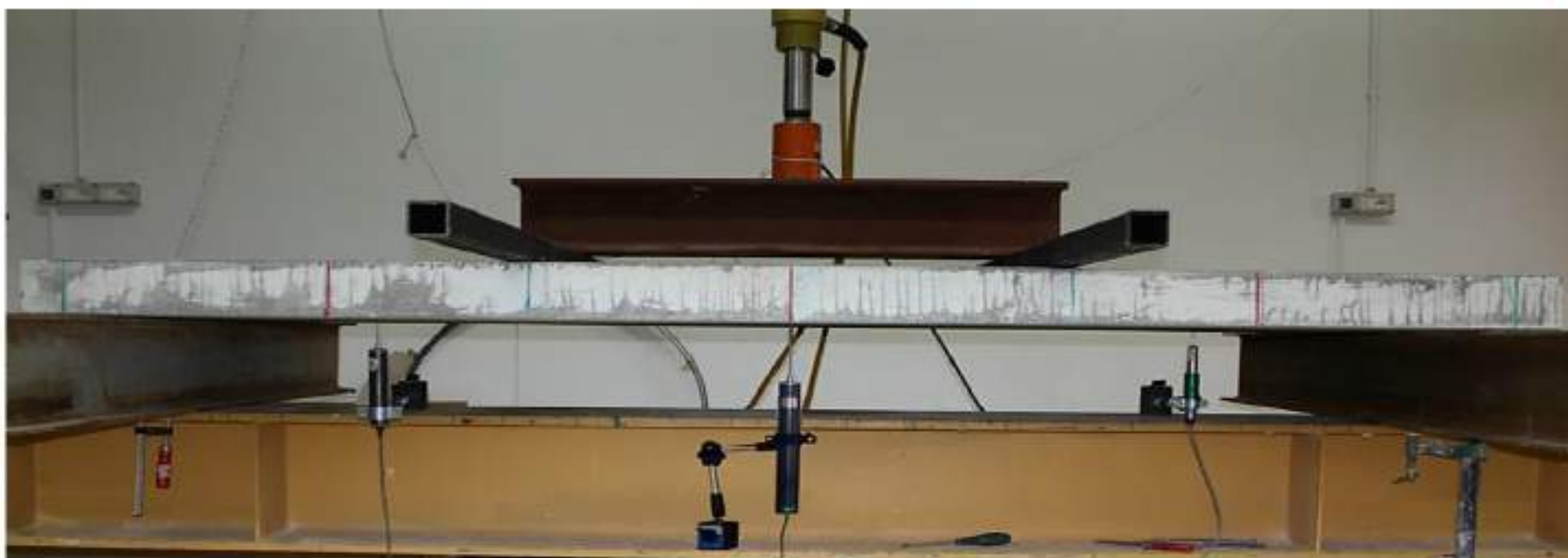



## PROVE SU PARTIZIONI IN EPS



*Le prove  
nell'ambito  
del progetto  
CADS*

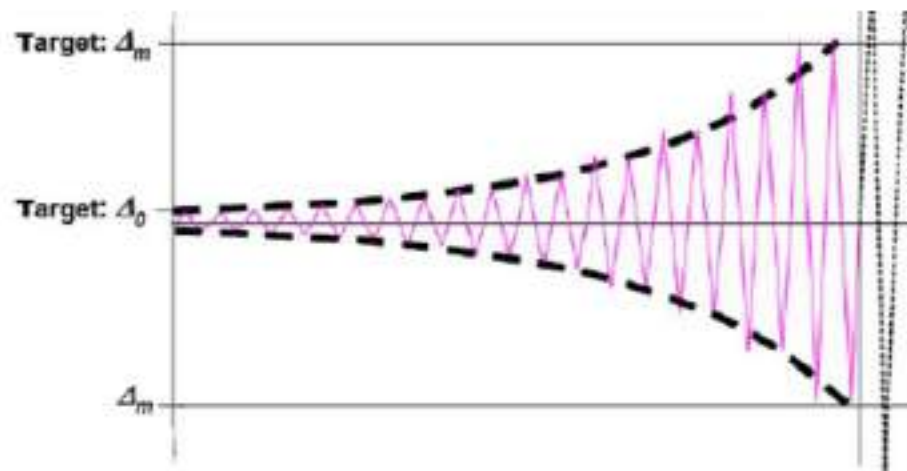

## PROVE SU DISSIPATORI SISMICI PER IMPIANTI

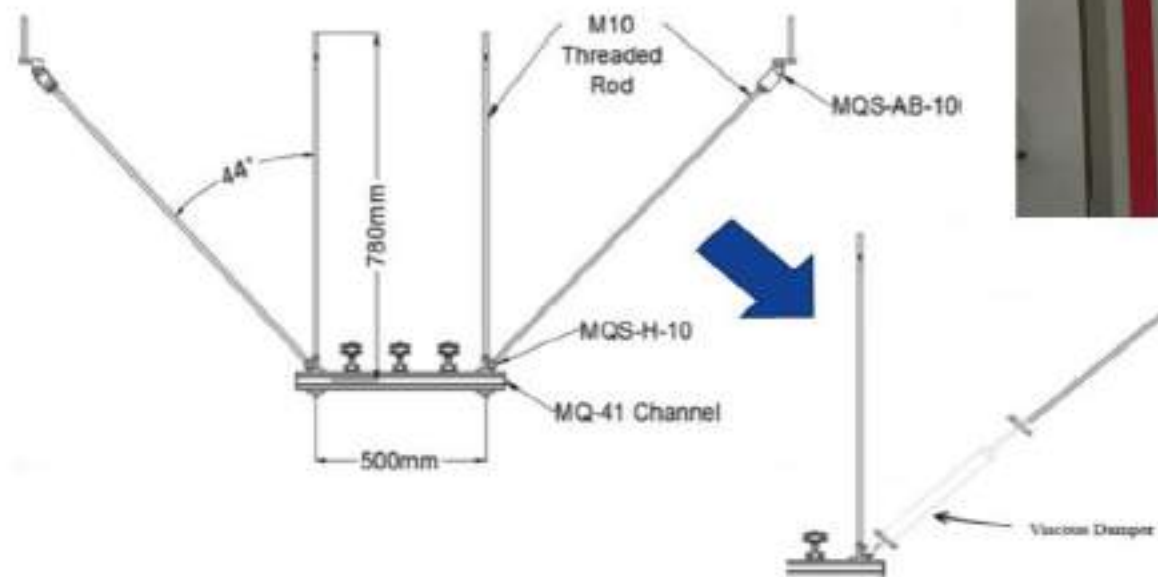

*Le prove  
nell'ambito  
del progetto  
CADS*



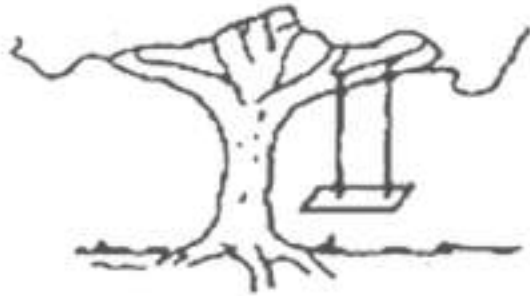

**What the client wanted.**



**The architect's solution.**



**The structural engineer's solution.**



**The non-structural engineer's Solution.**

**Grazie per  
l'attenzione**

[daniele.perrone@unisalento.it](mailto:daniele.perrone@unisalento.it)

## Partner



Creazione di un Ambiente Domestico Sicuro  
[www.progetto-cads.it](http://www.progetto-cads.it)